

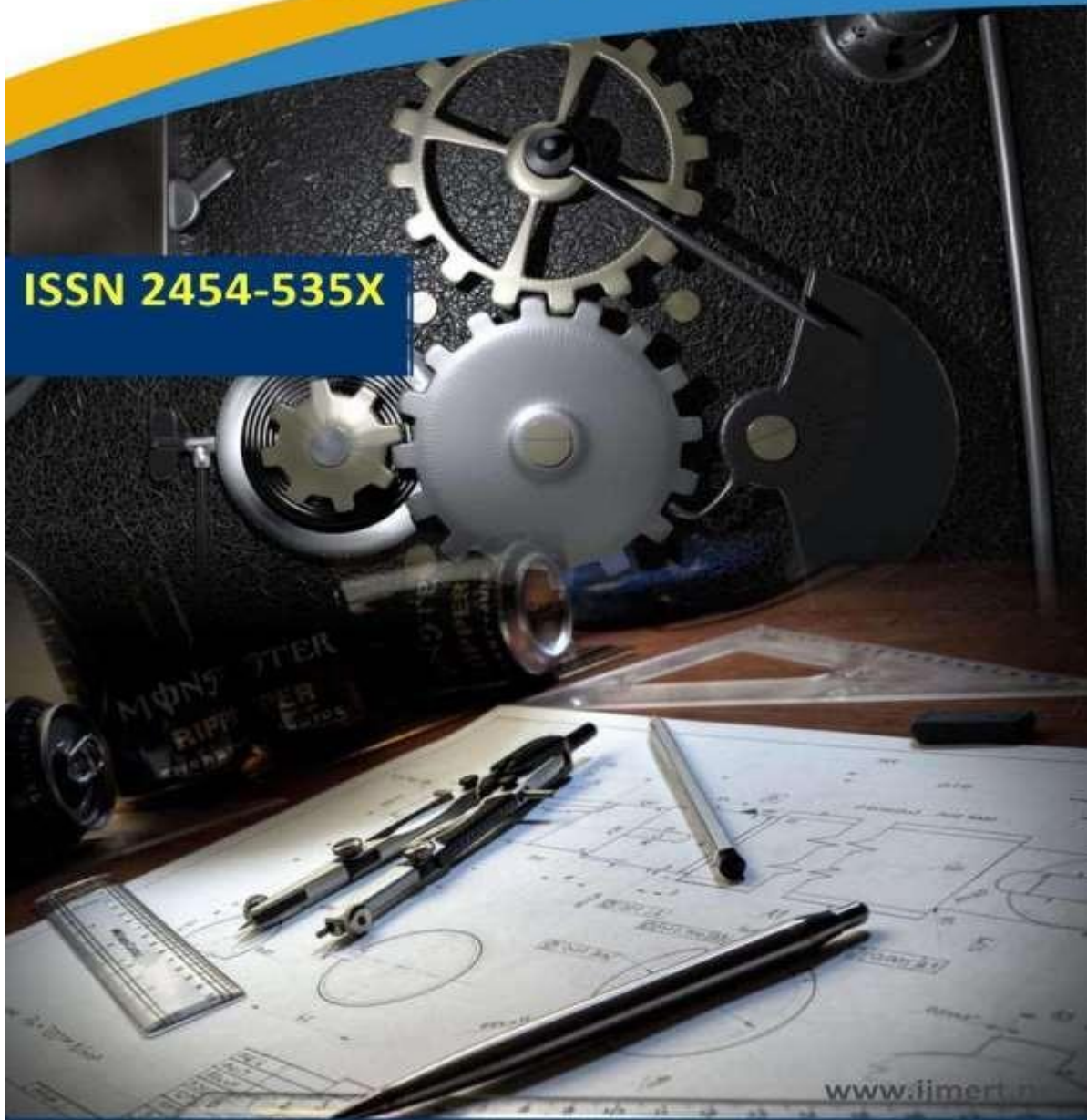

**International Journal of**  
Mechanical Engineering Research and Technology

**ISSN 2454-535X**



[www.ijmert.net](http://www.ijmert.net)

**Email ID: [info.ijmert@gmail.com](mailto:info.ijmert@gmail.com) or [editor@ijmert.net](mailto:editor@ijmert.net)**



# IoT BASED SMART DUSTBIN

## Project Guide

**Mr.A.TRINADHA RAO**

**Asst.Professor**

**GUNTI MANJU VANI**

**KOMMIREDDY NAGA MALLESWARI**

**VALLAPANENI DIVYA JYOTHI**

**VEERABOINA THIRUPATHAMMA**

**DEVANDLA SAI LAKSHMI**

---

## Abstract

Every single person on Earth disposes of their garbage in a trash can or some other designated area. The trash consists of both biodegradable and non-biodegradable polymers. Everyone is making an effort to use the trash can or recycling bin exclusively. It is common to observe overflowing trash cans and other waste containers in public spaces around cities. The result is an unsanitary environment. On top of that, it causes certain very dangerous illnesses. Simultaneously, a foul smell permeates the whole city, causing environmental degradation. Recycling bins are really a kind of waste management procedure; however, unlike regular trash cans, they do not need more waste. Effective waste disposal is the process of removing trash from public and commercial spaces like schools, universities, malls, and companies. We need to plan the project such that we can track when the garbage can is full and how much rubbish has been deposited inside. One piece of hardware needed to measure the trash can is the NodeMCU, which works in conjunction with an ultrasonic sensor. An IFTTT Webhook is the software component that is used for receiving notifications.

---

## INTRODUCTION

An IoT is one of the most well-known technologies in the world. The Internet of Things ("IoT") refers to a network that links various items. The ability to share and receive information is a key component of this technology. A few UNO boards, a motor, and sensors activate the IoT. Everywhere you look, you can see trash cans storing the world's refuse. As part of routine maintenance, a standard trash can is used to collect trash and then emptied. This

is the most basic use of a standard trash can, including no components, no code, and all physical labor. When trash cans are overflowing, people tend to toss their refuse all over the place, which leads to unpleasant odors and even illness. We used IoT and other technologies to ensure that the trash cans and surrounding area were always spotless in order to forestall this kind of issue.

---

**DEPARTMENT OF ELECTRONICS AND COMMUNICATION ENGINEERING**

**Guntur Engineering College**

**Jawaharlal Nehru Technological University, Kakinada.**

---



ISSN 2454 – 535X www.ijmert.com

Vol. 16 Issue. 1, May 2024

You may dispose of trash in a conventional trash can. Toss trash into a smart trash can that also serves as a level indicator. Integration of electrical components into a smart trash can, including NodeMCU, an ultrasonic sensor, and IFTTT web hooks. The smart dustbin is more efficient than regular trash cans. One piece of hardware that is incorporated with the smart bin is an ultrasonic sensor and NodeMCU. A NodeMCU is used to upload code and establish a Wi-Fi connection, while an ultrasonic sensor measures the distance and level of the trash can in this project. Notification servers may be sent via IFTTT webhooks. Here are some benefits of this method: In addition, when the trash is almost full, the one up there will send a notice to your phone. Making this trash can a "smart" trash can involves a number of technological components. Here are some drawbacks of this approach: In order for the cellphone to get alerts quickly, it needs a strong signal from a carrier. alerts will not be sent if the connection is weak.

## 1. LITERATURE SURVEY

After the Internet of Things (IoT) reached 10 cm intensity, the garbage can was suggested by [1]. The sensor triggers the GSM modem, which notifies the relevant authorities prior to the bin being emptied, whenever the amount of waste reaches the threshold. The conclusion states that when these smart bins were developed, many concerns were taken into consideration, including price, maintenance, and durability. In order to lower the value, they just used weight-based sensors, and the

The transmitter only relied on the Wi-Fi module for data transmission and reception. An ultrasonic sensor measures the volume of trash in the bin and

relays that data.

A strategy for community-wide trash collection coordination was proposed by the author [3]. An ultrasonic sensor can detect the quantity of trash in the bins and communicate that information to the region via GSM. The data was retrieved from several locations using a graphical user interface (GUI) that was backed by simulation. It was, therefore, exceptional. During the procedure, there were two types of units: one that was situated in an office and the other that was in a bin. If the sensor detects that there is too much garbage in the bin, it will send a signal to a slave device, which will then notify the administrators to empty the bin. According to the publication, a network has been used for the purpose of collecting garbage from an inside site [4]. With the help of the town's useless waste, the gadget was able to function in remote areas. There were two parts to the system. The first step was to compile a list of people who would be interested in a rubbish collection service or who might be in charge of organizing specific drivers to carry trash to various towns.

## 2. EXISTING METHOD

We want to construct an IoT-based system that can detect and appropriately dispose of such waste automatically as part of this research. When a trash can is full, every single individual on Earth takes out their trash and puts it in the trash. This is the most fundamental way to utilize a standard trash can, without the use of any components, code, or automation.

Additionally, the bin's upkeep is inadequate as the lid is leaking, causing the trash to spill



ISSN 2454 – 535X www.ijmert.com

Vol. 16 Issue. 1, May 2024

out. The second option is to utilize a dedicated trash can for recyclables or one that has separate sections for various types of trash, such as green and blue bins. The third approach is more expensive but achieves the same thing using an Arduino, servomotor, GSM module, and ultrasonic sensor. Inside the trash can, there's an ultrasonic sensor that measures the height of the garbage and sends a notification when it reaches 70 percent. Currently, the only way to do that is to send a notice.

whether a trash can is full or not. When a trash can reaches 70% capacity, it notifies the user via email that the can is almost full and modifies its status percentage accordingly. The NodeMCU data is collected via IFTTT Webhooks, which are used to send an email when the garbage level hits 70%. No longer will humans be required to physically check the trash cans; instead, a notification will be sent to us as soon as the garbage can is completely operational.

### 3. PROPOSED SYSTEM

With this method, an Internet of Things (IoT) trash can may be built. The current setup alerts you when the trash can is full. The air will become filthy and dangerous diseases may spread quickly if trash isn't disposed of correctly. The suggested plan would fix many of these problems. Actual sustainability is used to assess the capacity of garbage cans in order to determine whether they were finished or not. A smart bin consists of a sensor and a data-gathering and -transmitting node. We need to plan the project where we measure rubbish and finish the trash cans.

### BLOCK DIAGRAM

Presented below is the schematic representation of this undertaking. The application uploaded a code to connect with Wi-Fi after using an ultrasonic sensor to detect the height and distance on a trash can. NodeMCUs were then used. To read the NodeMCU's data, calculate the sensor's distance, and display the level on the serial monitor. A connection to the IFTTT webhook will be initiated as soon as the NodeMCU is created. Users may establish connections to other web-based services with the help of this applet. The next step is to link the project authentication ID to the IFTTT webhook private key.

In order to access a website, we can determine

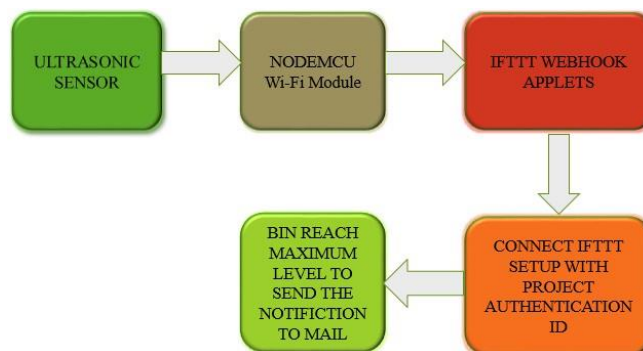



### 3.1 FLOW CHART

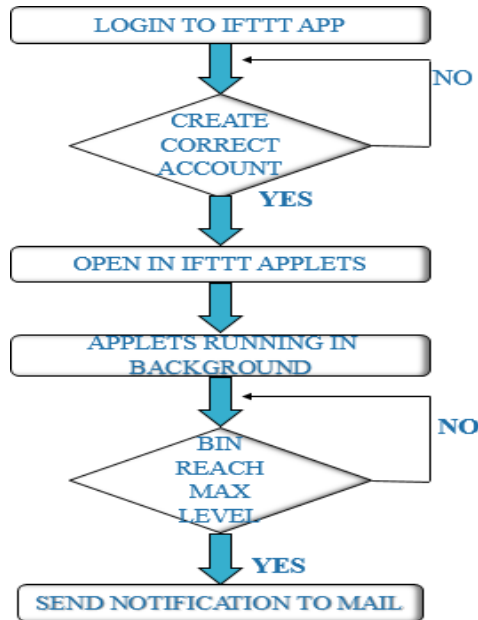

First of all we create an account in IFTTT webhook. Then open the applet and to connect mail id for send the notification. After that webhook private key and host id is connected with project code. Now the applet are start to work and generated the code in webhook server. If the bin reach maximum level, the server start to send the notification to particular mail otherwise it doesnot send the message to mail.

### ULTRASONIC SENSOR

A distance is determined with great sensitivity and correct measurements by an ultrasonic sensor. A Ultrasonic sensor have four pins. Two pin are VCC , GND the other two pin are: The information would be supplied by the trig pin, while it would be absorbed by the echo pin.

$$\text{Distance} = \text{Time} * \text{Velocity of sound} / 2$$

Where Time= is the time transmitted and received between an ultrasonic wave.





Figure 3: Ultrasonic Sensor

### 3.2 NODEMCU

NodeMCU is an open-source IoT project that is completely free and it is used for Wi-Fi to make things work. A NodeMCU can be powered through a USB port and this pin can be supplied with regulated 3.3v to power the board. There are 16 general purpose input-output pins for NodeMCU.

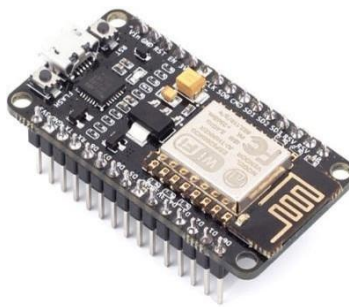

Figure 4: NodeMCU

### 3.3 IFTTT SETUP

IFTTT is commonly referred to as a web-based service that allows users to connect between web services as IF This Then That. To create conditional trigger chains that work on certain websites, including Microsoft outlook and Twitter message and Facebook. The conditional chains are referred to as applet.

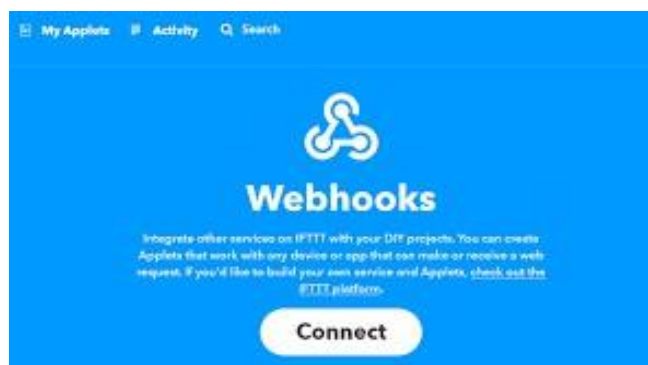

Figure 5: IFTTT Webhooks

### 3.4 CIRCUIT DIAGRAM

We are interconnecting a ultrasonic sensor with a NodeMCU. The VCC and the GND pin of a sensor connected to 3.3V and the GND pin of the NodeMCU. The Trigg pins are connected with a D6 pins, while the information-gathering pins are connected to D5 pins.

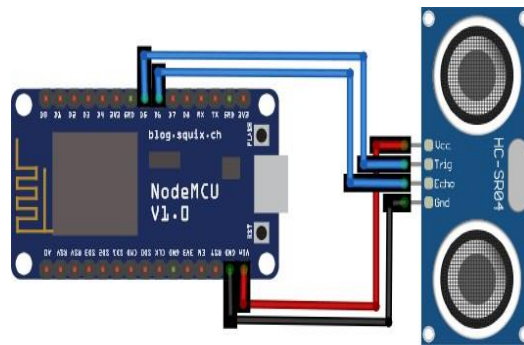

Figure 6: Circuit Diagram for Smart Dustbin

## 4. RESULT

### 4.1 Simulation part

To upload and compile the code, once the hardware and coding was done. The main purpose in this method is: To upload the code in NodeMCU through USB port and the Node MCU (esp8266 Wi-Fi) is connect to mobile Wi-Fi and ultrasonic sensor also connected. If the NodeMCU and the ultrasonic sensor was generated, a IP address, distance and level are displayed on a serial monitor.

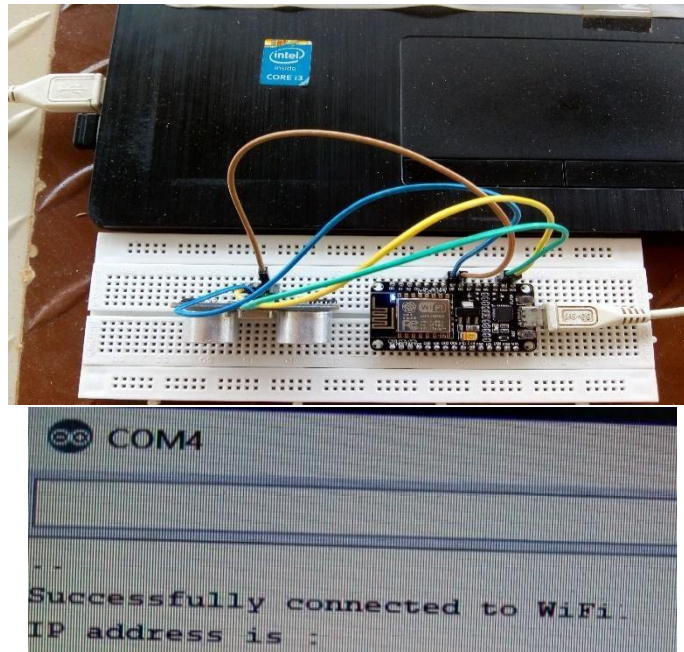

Figure 7: Hardware connections of the smart dustbin

## 4.2 Output status of empty dustbin

The NodeMCU is attached to the ultrasonic sensor and the ultrasonic sensor was positioned in the maximum level to an empty dustbin. And a code is upload toNodeMCU and an ultrasonic sensor measure the distance and level of the dustbin. Then, use an IP address and a level, to check a webpage to show a garbage bin percentage.

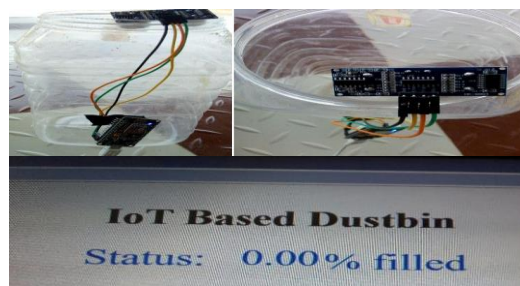

Figure 8: Initial status of the smart dustbin

## 4.3 Measuring the waste level



ISSN 2454 – 535X www.ijmert.com

Vol. 16 Issue. 1, May 2024

Again the same procedure is done with some waste. Use an IP address to check a serial monitor and a webpage to show the dustbin's waste level. Then an IFTTT Web is connected to send an email if a trash bin is above 70%.

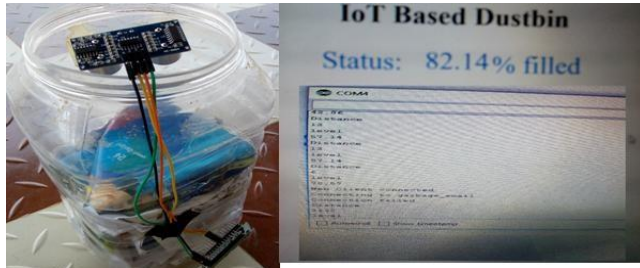

## 5. CONCLUSION

Think about how bad it would be for your health if your workplace was unclean and the need to make it better for people to breathe. When the amount of trash in the container becomes too high, this mechanism will clean the recycling bin. Each suggests a smart trash can system that makes use of a NodeMCU and an ultrasonic sensor. Vehicles devoted to trash collection run continuously across urban areas, with an emphasis on expanding regions; nevertheless, not every trash can is guaranteed to be full. The trash cans throughout the city will be able to be followed by this gadget according to the plans. The accuracy of these garbage cans can be seen at any moment by anybody using their technological devices. The trash can is emptied more quickly and easily with the help of a smart trash can. It is deemed waste to pass something that has been thrown out into a busy place, a social organization, a school, or an apartment. Interest in "Internet of Things technology" and its potential use in "Smart City applications" is central to the project. Reducing future garbage can use is the goal of the campaign. Getting the trash can and surrounding area clean is the primary goal. In order to determine the maximum height that

trash cans can be filled to, this technique is used regularly. An instantaneous email alert may be issued if a trash can's level is approaching 70%. Preventing the spread of illness and maintaining a clean environment are both helped by it.

## FUTURE ENHANCEMENT

A step toward IOT implantation is this approach outlined above. All of the Internet of Things (IoT) smart trash can techniques work well for garbage collection. The highest points of trash can contents are used by an ultrasonic sensor. A wide range of systems may make use of many gadgets.

## REFERENCES

- Article titled "Smart Dustbin" published in the International Journal of Industrial Electronics and Electrical Engineering in 2015 by Twinkle Sinha, Mugesh Kumar, and P. Saisharan, pages 101–104.
- [2] "Smart Garbage Management System" in International Journal of Engineering Research & Technology, volume 4, number 3, pages 1117–1119, by Pankaj Vikrant Bhor<sup>1</sup>, Maheshwar



Morajkar<sup>2</sup>, Dishant Gurav<sup>3</sup>, and Pandya (2015). International Journal of Engineering Science and Computing, volume 6, pages 7113–7116, 2016. [3] "Smart Dustbin—An Efficient Garbage Monitoring System" by Monika K. A., Rao N., Prapulla S. B., and Shobha G. [4] "IoT Based Smart Garbage and Waste Collection Bin" in the International Journal of Advanced Research in Electronics and Communication Engineering (IJARECE) vol. no. 5, pp. 1576–77, by Navghane, Killedar, and Rohokale (2016).

In their 2016 article "Garbage Management Using Internet of Things for smart cities," Kasliwal<sup>Manasi H</sup> and Suryawanshi<sup>Smithkumar B A</sup> presented a fresh perspective on the topic. The article was published in the International Journal of Current Trends in Engineering & Research, volume 2, pages 348–353. "Waste management as an IoT-enabled service in smart cities" (pp. 104–15) in Conference on Smart Spaces (Springer International, 2016) by Alexey Medvedev, Petr Fedchenkov, Arkady Zaslavsky, Theodoros Anagnostopoulos, and Sergey Khoruzhnikov.

"Smart garbage monitoring system for waste management" (Yusof, N.M., Jidin, A.Z., & Rahim, M.I., 2017), MATEC Web of Conferences Engineering Technology International Conference, vol. 97, EDP Sciences, p.01098. In their article "Solid waste management," Guerrero, Maas, and Hogland discuss the difficulties faced by urban areas in underdeveloped nations. Waste Management Journal.

[9] "IoT Based Waste Monitoring For Smart City" in International Journal of Engineering and Computer Science, by Shambala S. Salunkhe, Madhuri D. Yadav, and Vrushali V. Kulkarni,

ISSN 2454 – 535X [www.ijmert.com](http://www.ijmert.com)

Vol. 16 Issue. 1, May 2024

published on 4 April 2017. [10] "IoT Based Smart Garbage alert system using Arduino UNO," published in the 2016 November 22–25 issue of the TENCON conference proceedings by Dr. N. Satish Kumar, B. Vijayalakshmi, R. Jenifer Prathana, and A. Shankar. [12] Saji Ruhin, Gopakumar Drishya, Kumar Harish, and Lakshmi "Smart Garbage management in cities using IOT: A survey" published in the international journal of engineering and computer science.