



International Journal of Mechanical Engineering Research and Technology

ISSN 2454-535X

www.ijmert.net

Email ID: info.ijmert@gmail.com or editor@ijmert.net



DESIGN AND ANALYSIS OF POTATO HARVESTER

Mr.T.Aravind Assistant Professor, Department Of MECH, SICET ,Hyderabad

Kavalip Prashanth Kumar, Valakonda Sharath, Bojja Nithin, S Sai Krishna

Department Of MECH, SICET, Hyderabad

ABSTRACT

Potato is one of the most important food crops in the world, which is of great significance for sustainable agricultural development. The mechanization of potato planting & harvesting technology is an effective method of increasing potato yields. A variety of potato planting & harvesting technologies and machines have been developed around the world. The aim is to solve the current problems of time-consuming manual work and low harvesting & planting efficiency of potato. As the technology and methods used in harvesting and planting are still in their infant stage more technological advancements are yet to revolutionize the industry. This design of potato harvester and planter focuses to solve problems related to potato harvesting and planting such as cost, efficiency availability and ease to use.

Keywords- potato, mechanization, manual work, harvesting, revolutionize.

INTRODUCTION

The potato (*Solanum tuberosum* L.) is an exceptional crop with a rich history, originating from the Peru-Bolivia region nestled in the Andes of South America. Its remarkable capacity to yield a substantial biomass daily position it as a promising crop for regions burdened with high population densities. Notably, potatoes distinguish themselves as a nutritionally well-rounded crop, surpassing many major food crops in protein and calorie yields per unit area and time. This characteristic

renders potatoes an attractive non- traditional crop choice, pivotal in securing food stability.

Furthermore, the nutritional profile of potatoes is impressive. Abundant in potassium and low in sodium content, they offer substantial benefits for individuals managing conditions such as high blood pressure. Their

versatility in culinary applications further solidifies their status as a staple food source in various regions. Despite its immense potential, the potato industry often grapples

with the volatility of production, marked by periods of surplus & scarcity. This inconsistency underscores the pressing need for strategic interventions

aimed at achieving sustainable production levels.

Implementing practices that optimize resource utilization, minimize waste, and fortify resilience against environmental pressures can significantly contribute to stabilizing potato production and ensuring a steady food supply.

In conclusion, the potato's unique attributes make it a vital player in addressing food security challenges, particularly in regions characterized by dense populations.

However, achieving sustainable production necessitates proactive measures to mitigate production fluctuations and market instability, ultimately safeguarding a consistent and reliable food source.

The development, testing, and evaluation of



agricultural machinery have emerged as significant challenges that warrant comprehensive examination. This issue has gained prominence due to the expanding agricultural areas where machinery plays a pivotal role in enhancing productivity. However, it's observed that agricultural machines tested in one country may not yield identical outcomes when deployed in another. This discrepancy can largely be attributed to local conditions such as soil composition, fuel quality, lubricants, labour availability, and climate variations. These factors can substantially influence the performance and efficacy of agricultural machinery.

Given these complexities, it is imperative to undertake rigorous efforts in developing, testing, and evaluating agricultural machinery tailored to local conditions. Of particular importance is the harvesting process, which is a critical operation in potato production. Root crops, being subterranean, necessitate specialized machinery for digging and separating them from the soil efficiently.

Potato stands as a cornerstone within global foodcrop production, bearing immense significance for fostering sustainable agricultural advancement. Within this realm, mechanized planting emerges as a pivotal technical facet in mechanized agricultural production, constituting an indispensable component within the potato cultivation sector. The mechanization of potato planting technology represents a potent means of elevating potato yields to meet growing demand. Across the globe, a plethora of potato planting technologies and machinery innovations have been cultivated, underscoring the concerted efforts toward enhancing efficiency and productivity in potato cultivation practices. This is mentioned in the study proposed by Baidong Zhou, Yexin Li, Cong Zhang, Liewang Cao, Chengsong Li, Shouyong Xie and Qi Niu [1].

As per Ciaran mical johnson and Fernando Auat chein Potatoes are the fourth most important crop for human consumption. In the 18 centuries, potatoes saved the European population from starvation, and since then, it has become one of the primary crops cultivated in countries such as Spain, France, Germany, Ukraine, and the United Kingdom.

Potato production worldwide reached 368.8 million tonnes in 2019, 371.1 million tonnes in 2020, and 376.1 million tonnes in 2021, with production expected to grow alongside the worldwide population [2].

Weijing Wang¹, Ranbing Yang^{1,2}, Zhiguo Pan¹, Yiren Qing², Jian Zhang^{1,2}, Dongquan Chen², Xinyu Guo¹ and Shiting Lyu¹ proposed a that study delves into the examination of the force, motion, and collision dynamics experienced by potato plants during both the digging transition stage and the subsequent conveying and separating stage. Through rigorous analysis, the study aims to identify the pivotal factors influencing the rate of single plant integrity as well as the incidence of injured potatoes. By elucidating these key factors, this research endeavours to provide valuable insights into optimizing potato harvesting processes for enhanced efficiency and reduced crop damage [3].

Ping zhou, lou wang, jizei zhao, Xueiwei bai, Published on International Conference on Logistics Engineering, Management and Computer Science (LEMCS 2015)

This paper introduces an innovative bionic design concept and a novel parameter design theory, presenting specific strategies to guide the development of future digging shovel designs. This endeavour holds profound significance in enhancing the efficiency and effectiveness of potato digging shovels, while also offering valuable insights into optimizing soil dynamics analysis methods for tuber crop harvesting [4].

The paper published by Jianghong Wei shows that A feature-based parametric modelling software, Autodesk Inventor, is used for the main working subassemblies of 4U1A Potato Harvester modelling. The movement of swing sieve, a key part of potato harvester, is simulated using the ADAMS. The complex velocity, acceleration, and displacement curves as well as collision pressure curves are analysed to provide theoretical foundation for the work of 4U-1A Potato Harvester [5].

Lili Xina*, Jihui Liang b proposed a harvester

that comprises a structured framework housing several integral components, including a soil cutting plate, an excavation device, six tiers of potato separation conveying apparatus, a potato collection mechanism, and a propulsion system. Each component functions in synergy to facilitate efficient potato harvesting. Notably, the first-tier separation conveying device utilizes a quincunx-shaped vibrator, which operates at a high frequency to gently vibrate the conveyed potato-soil mixture, effectively disintegrating large clods while safeguarding potatoes from collisions, thereby minimizing

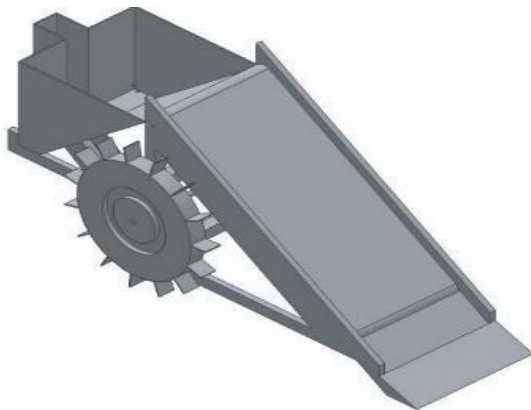

potential damage. Subsequent tiers employ specialized mechanisms such as finger-shaped angle of inclinations between notches = 40 degree (assumed)

Assumed clearance = 5 cm Length of digger

$$= 25 + 5 / \sin(40) \quad l_d = 46.671 \text{ that's } 47 \text{ No}$$

of notches (n) = 5

Width of digger = $b_d = 70 \text{ cm}$

Load on digger blade = volume of soil in digger

Volume of soil "v soil" $V_{\text{soil}} =$

$A * H$

$$\begin{aligned} \text{Volume of soil} &= (0.7 * 0.47) * 0.25 \\ &= 0.08225 \\ &= 0.08 \text{ m}^3 \end{aligned}$$

claw conveyors, soil dumping functionalities, roller brushes, and disk rotation shafts, each serving distinct roles in further refining the separation process and enhancing potato quality [6].

The innovative design of this harvester enables automated potato excavation, separation, conveying, and harvesting, thereby significantly augmenting overall efficiency and yield quality. The findings presented in this study offer valuable insights and benchmarks for the development and refinement of potato combine harvesters, paving the way for enhanced agricultural mechanization and productivity.

1. ANALYTICAL WORK

Design and Calculation.

Fig1: proposed design of potato harvester and planter.

Calculations: -

Reference for calculations [13].

Given: - maturation occurs at depth of 25 cm

Weight of soil “W of soil”

W of soil = Mass of soil *gravity As we

know,

Mass of soil = ρ of soil* V of soil

W of soil = ρ of soil * V of soil * g

$$= 2200*0.08*9.81$$

W of soil=1726.56N

For more safety we assume factor of safety c3

$$\text{Weight of soil} = 1726.56*3$$

$$= 5179.68$$

2. FEA analysis using Ansys.

2.1 For Frame

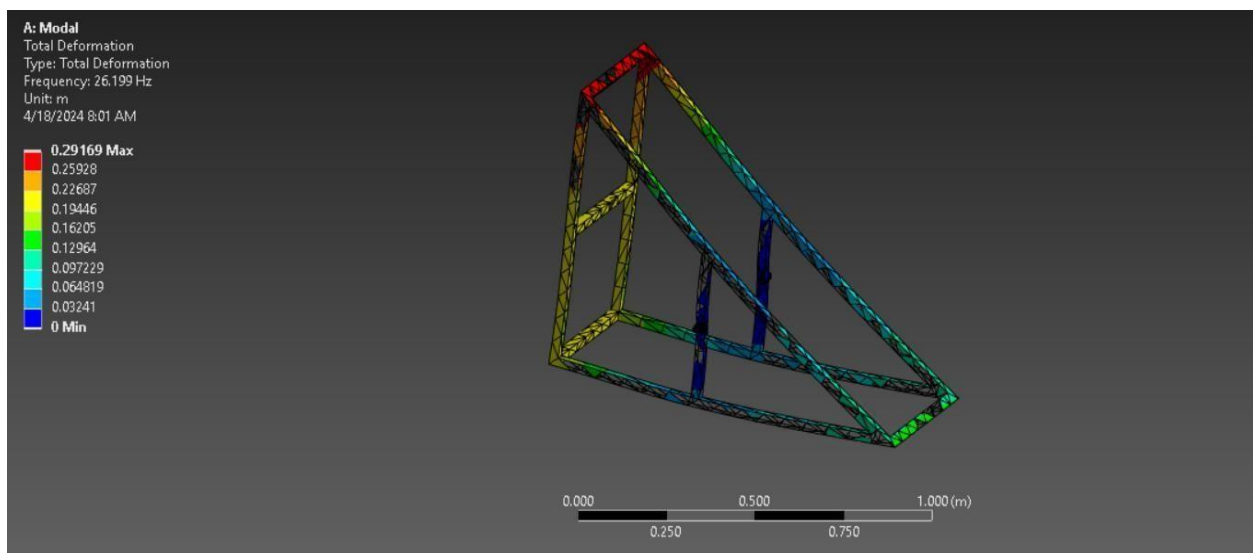

Fig no 3.1.1 Modal Analysis of Frame

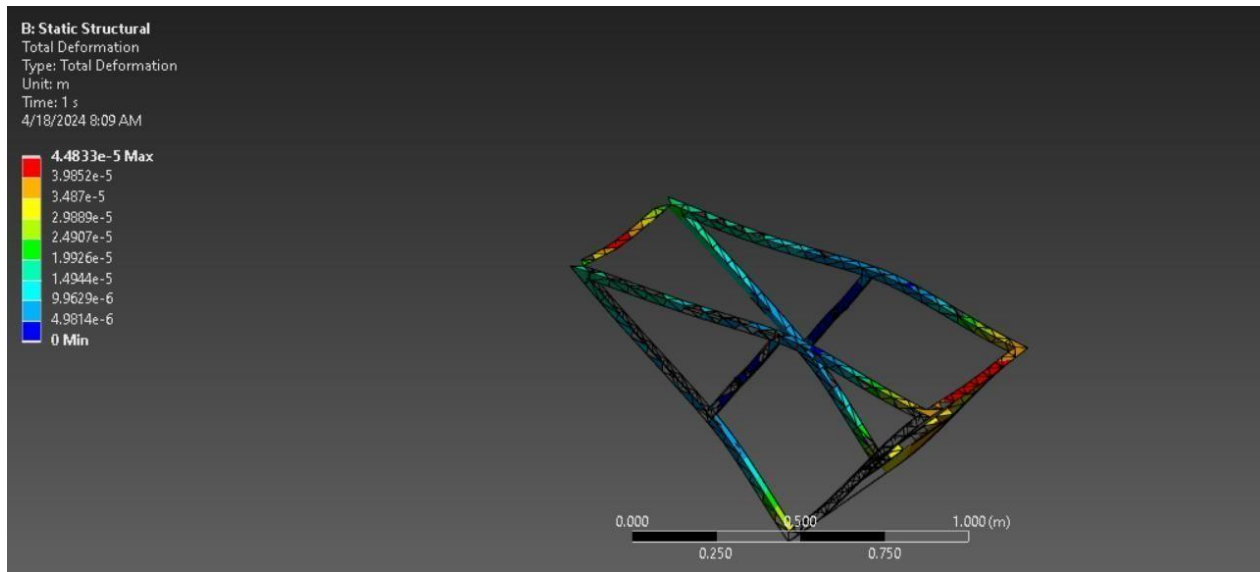

Fig no 3.1.2 Static Structural Analysis (Total Deformation) of frame

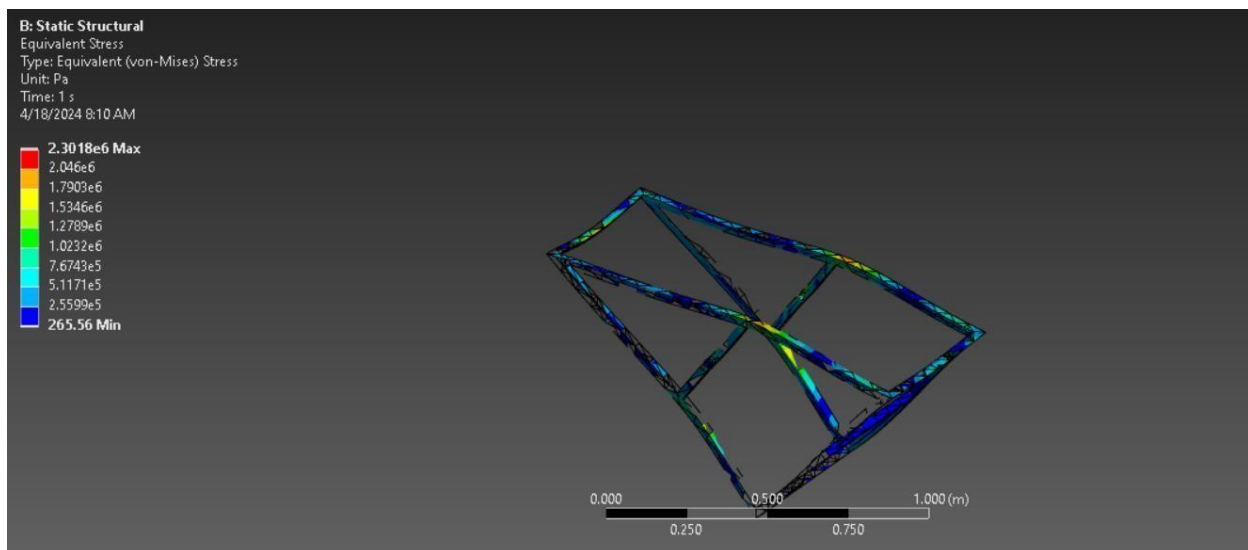

Fig no 3.1.3 Static Structural Analysis (equivalent stress) of frame.

2.2 For Digger

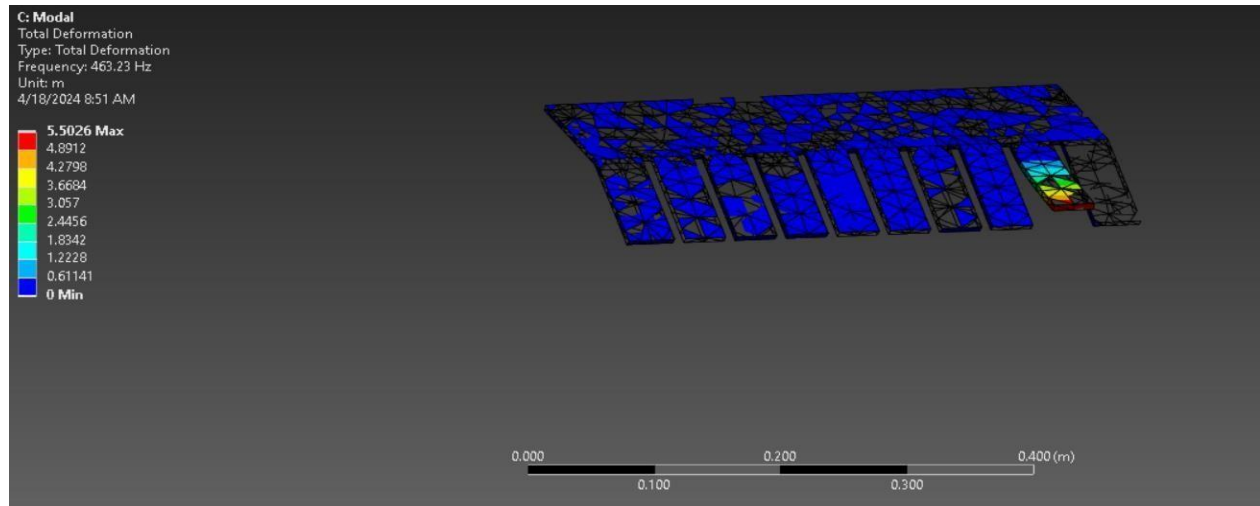

Fig no 3.1.4 Modal Analysis for Digger.

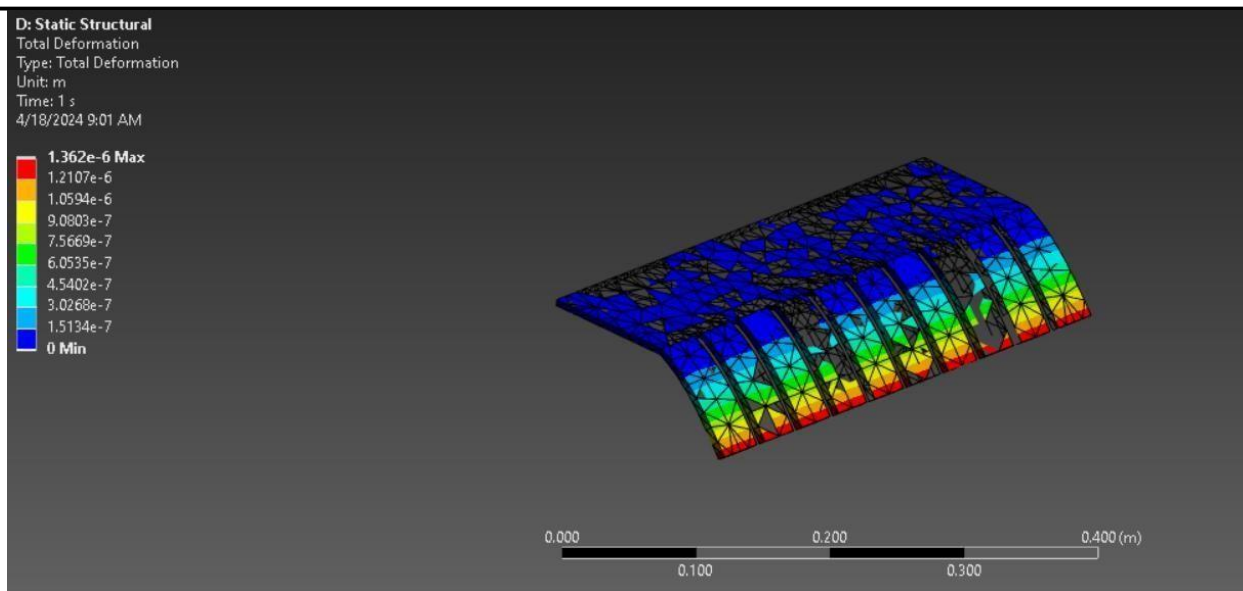

Fig 3.1.5 static structural analysis (total deformation) of digger

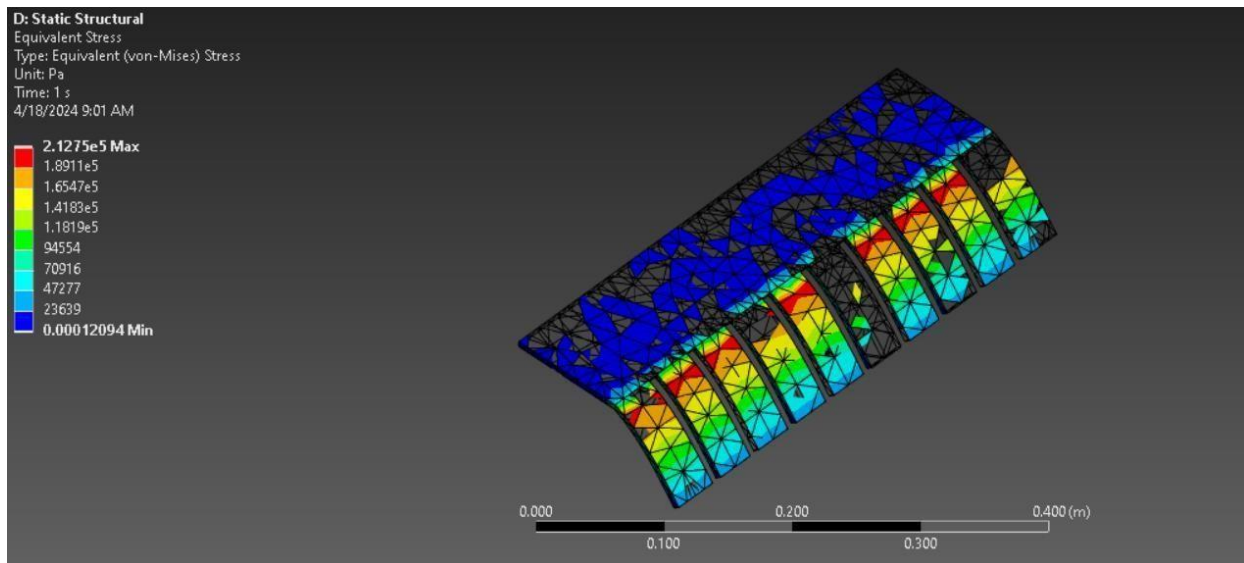

Fig 3.1.6 static structural analysis (equivalent Stress) of digger

3. CONCLUSION

planting techniques of potatoes by designing and fabricating a small-scale harvester & planter which is less costly and easy to use which will provide access for small scale potato farmer to use latest harvesting and planting machines rather than less efficient and time-consuming manual labour.

This harvester and planter have both planting and harvesting mechanisms which is integrated and combined into one assembly to increase efficiency and boost usability.

It digs the potatoes with the digger in front and with the help of conveyor gets transported or collected into the collection unit/tank thus

Mechanize the traditional harvesting and reducing the need of collecting the potatoes manually one by one. This collecting unit/tank is further connected to the planter which comprises of planting mechanism. Which drops the potatoes into the channel dug by digger and simultaneously burrowing the potatoes by covering it with soil for it to take root under the soil bed. This design is flexible and can adjusted as per need be it planting or harvesting.



4. REFERENCES

1. Zhou, B.; Li, Y.; Zhang, C.; Cao, L.; Li, C.;
2. Xie, S.; Niu, Q. Potato Planter and Planting Technology: A Review of Recent Developments. *Agriculture* 2022, 12, 1600. <https://doi.org/10.3390/agriculture1210160>
3. Johnson CM and Auat Cheein F (2023) Machinery for potato harvesting: a state-of-the-art review. *Front. Plant Sci.* 14:1156734. doi: 10.3389/fpls.2023.1156734
4. Wang, W.; Yang, R.; Pan, Z.; Qing, Y.; Zhang, J.; Chen, D.; Guo, X.; Lyu, S. Design and Experimental Study of Single Plant Harvester for Potato Breeding Experiments. *Agriculture* 2024, 14, 71. <https://doi.org/10.3390/agriculture14010071>
5. Ping zhou, lou wang, jizei zhao, Xueiwei bai, (2015) Published on International Conference on Logistics Engineering, Management and Computer Science (LEMCS 2015). Design Situation and A New Design Idea of Potato Digging Shovel.
6. Jianghong Wei (2009) Mechanical and Electronic Engineering Department Dezhou University. Virtual Design and Simulation of 4U-1A Potato Harvester 978-1-4244-5268-2/09/\$25.00 ©2009 IEEE
7. Lili Xina*, Jihui Liang b. design of a new potato combine harvester. *Acta Mechanica Malaysia (AMM)* 5(2) (2022) 44-46. doi:<http://doi.org/10.26480/amm.02.2022.44.4>
8. Ahangarnezhad, N., Najafi, G., and Jahanbakhshi, A. (2019). Determination of the physical and mechanical properties of a potato (the agria variety) in order to mechanise the harvesting and post-harvesting operations. *Res. Agric. Eng.* 65, 33–39. doi: 10.17221/122/2017-RAE
9. Lu J.Q., Sun H., Dui H., Peng M.M., YU J.Y., (2017). Design and Experiment on Conveyor Separation Device of Potato Digger under Heavy Soil Condition. *Transactions of the Chinese Society of Agricultural Machinery*, 48(11): Pp. 146-155.
10. Li Y., Gao B., Yan J.Y., Liu J.S., et al., 2015. Development of potato harvester with elevator loading function. *Journal of Chinese Agricultural Mechanization*, 36(5):Pp. 50-53.
11. Crary Lockwood Needle-Type Potato Planter (2022). [EB/OL]. Available online: <http://www.lockwoodmfg.com/LockwoodPotatoEquipment/Planters/PickPlanters#> (accessed on 1 July 2022).
12. Sun, W.; Liu, X (2017) Design of potato casing soil planter in all-in-one machine combined with fertilizing, sowing, ridging, complete film mulching



and planting line covering. *Trans. Chin. Soc. Agric. Eng.* 2017, 33, 14–22

13. Harahagazwe, D., Condori, B., Barreda, C., Bararyenya, A., Byarugaba, A. A., Kude, D. A., et al. (2018). How big is the potato (*solanum tuberosum* l.) yield gap in subsaharan africa and why? participatory approach. *Open Agric.* 3, 180–189. doi: 10.1515/opag-2018-0019.

14. V.M.Mhetre¹, A.A.Surve², P.R.Shirke³, V.S.Patil⁴, S.A.Mali⁵, K.M.Swami⁶, V.S.Gondkar⁷ (2021). Design and Development Potato Harvesting Machine. *International Journal of Innovative Studies in Sciences and Engineering Technology* ISSN 2455-4863
DOI:<https://doi.org/10.20431/2455-4863.070205>