

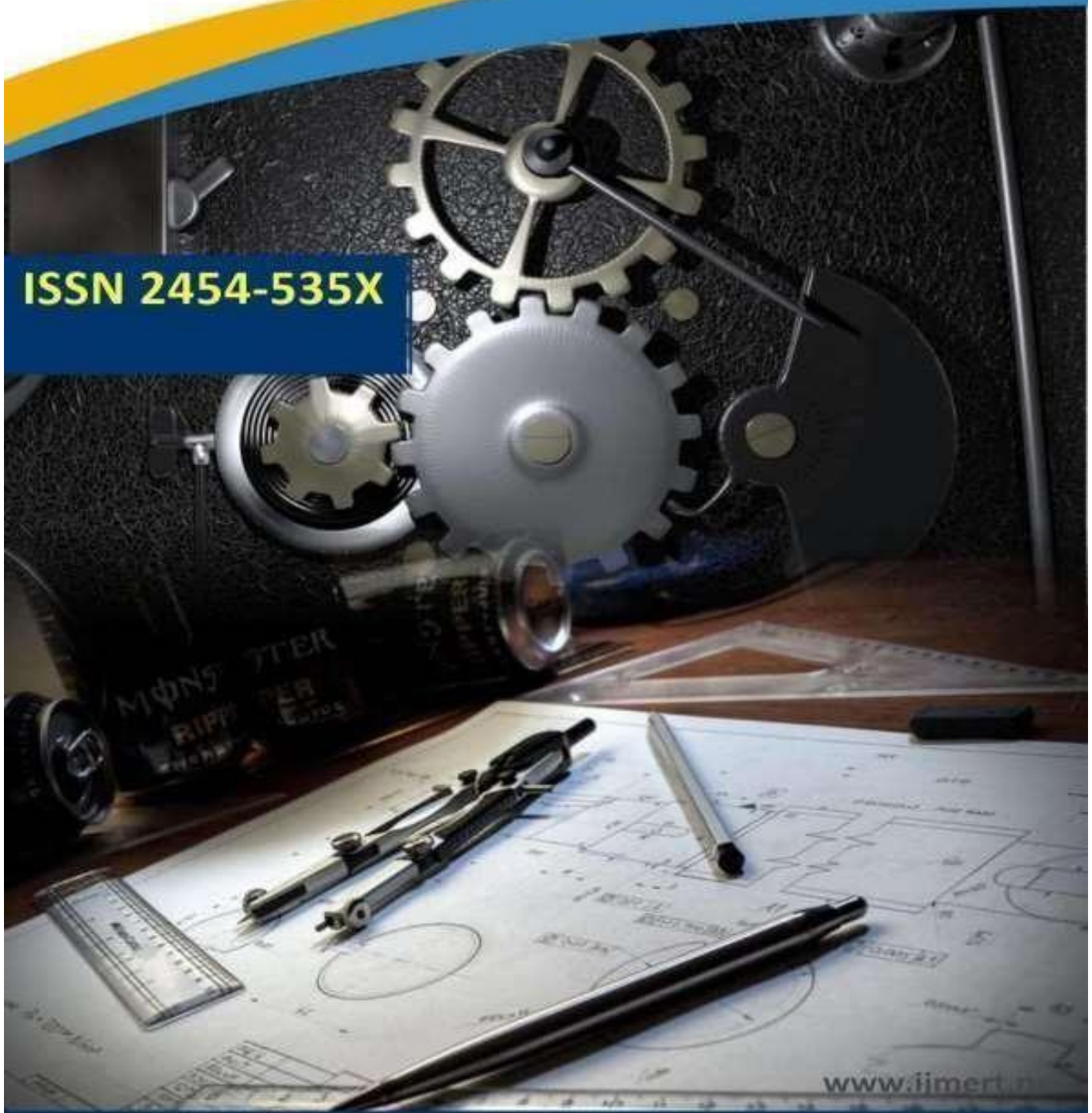

# International Journal of Mechanical Engineering Research and Technology

**ISSN 2454-535X**



[www.ijmert.net](http://www.ijmert.net)

**Email ID:** [info.ijmert@gmail.com](mailto:info.ijmert@gmail.com) or [editor@ijmert.net](mailto:editor@ijmert.net)



# DESIGN AND ANALYSIS OF KNUCLE JOINT USING ANSYS WORKBENCH

Dr.P.Malleshm Professor and Director, Department Of MECH, SICET ,Hyderabad  
 Pakkurthi Kishan Yadav, Pujari Ram Sai, S Dinesh Kumar, Vaka Chaitanya  
 Department Of MECH, SICET ,Hyderabad

## ABSTRACT

A knuckle joint is used to connect two rods under tensile load. This joint permits angular misalignment of the rods and may take compressive load if it is guided. These joints are used for different types of connections e.g. tie rods, tension links in bridge structure. In this, one of the rods has an eye at the rod end and the other one is forked with eyes at both the legs. A pin is inserted through the rod end eye and fork-end eyes and is secured by a collar and a split pin. Screwed connections often play an important part in the transmission of load through machine assemblies. The paper reports on design and analysis of a knuckle joint which is used in power transmission. In this study, modeling and analysis of a knuckle joint was performed by using Finite Element Method. The modeling of the knuckle joint is done using 3D software. Here we will be using CATIA V5 for modeling. The simulation part will be carried out using the Analysis software, ANSYS WORKBENCH 19.0. In order to increase the efficiency of working suitable material is required so we have chosen the suitable materials like galvanized iron and carbon fiber. The structural behavior of the knuckle joints after applying this material is compared with the normal existing default material and the obtained results help to choose the best suitable material for manufacturing the convenient knuckle joint.

## 1. INTRODUCTION

Knuckle joint is a type of mechanical joint used in structures, to connect two intersecting cylindrical rods, whose axes lie on the same plane. It permits some angular movement between the cylindrical rods (in their plane). It is specially designed to withstand tensile loads.

A typical knuckle joint has the following parts:

FORK END

EYE END

KNUCKLE PIN

COLLAR

TAPER PIN

Taper pin Coaxial holes are provided in the fork end, eye end and collar. The fork end and the eye end are held together in position by means of a knuckle pin. The knuckle pin is held in its position with the help of a collar and a taper pin.

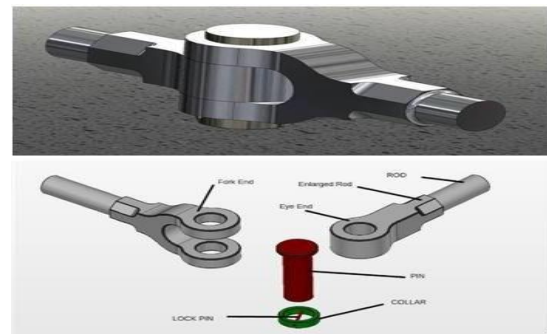

The assembled view of a knuckle joint is shown in the image below. Both the fork end and the eye end are capable of rotating in their planes about the axis of the knuckle pin.

**2. CAD MODELLING**

Finite element analysis first step is to create CAD model. A knuckle joint having diameter 35mm subjected to tensile force has been taken into consideration. Fig 1 shows the drawing and dimension of knuckle joint for the present study. CAD model of knuckle joint in CATIA V5 R20 is prepared according to these dimensions. Fig 2 shows the assembled CATIA model of knuckle joint.

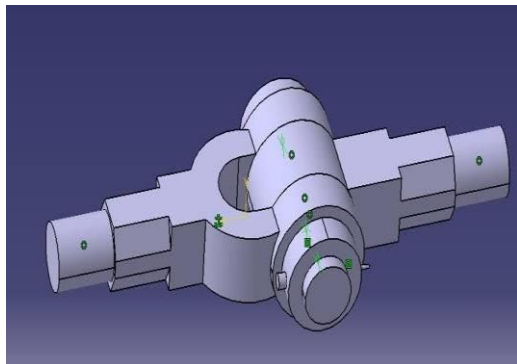

MODELLED IN CATIA

**3. STRUCTURAL ANALYSIS USING ANSYS**

Finite element analysis is an indispensable technology used in modelling and simulation of advanced engineering problems such as manufacturing transportation, housing and building design. Knuckle joint having diameter 35mm is taken into consideration. After converting assembled CATIA model into IGS format it

is then imported into ANSYS 15.0. Fig 3 shows the meshed model of original knuckle joint in ANSYS having 19250 nodes and 10016 elements.

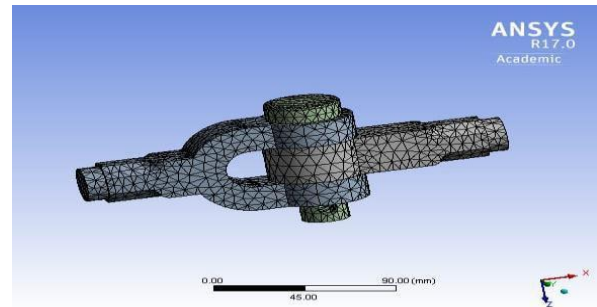

**MESHING**

**4. MATERIALS USED**

The material must be selected such that it must have sufficient hardenability and strength for the size involved. In the present work Aluminum alloy, Structure steel have been taken as material for knuckle joint for stress and deformation analysis in Ansys workbench. Table 1 shows the mechanical properties of, aluminum, structural steel, stainless steel and gray cast iron taken into consideration for analysis.

**TABLE1. Mechanical properties for Knuckle joint of Aluminum alloy, Cast iron, Structure steel.**

Mechanical property	Aluminum alloy	Structural steel
$\rho$ (kg/m <sup>3</sup> )	2770	7850
E(Pa)	7.1 E+10	2.0E+11
NU(Poisson ratio)	0.33	0.3
Tensile yield strength (MPa)	280	250



### 5. RESULTS AND DISCUSSION

The results of von mises stresses in knuckle joint made of aluminum have been obtained under the load of 150 KN through linear static analysis. Figures 4,5 and 6 show the stresses developed in knuckle joint made of aluminum alloy and structure steel under load of 150 KN respectively. The stresses developed in knuckle joint made of aluminum alloy is 371.73 MPa, structure steel 516.23 MPa and deformations 0.22526 mm, 0.13481 mm, 0.22729mm under load of 150 KN respectively. It has been found that knuckle joint made of aluminum have low stress 371.73 MPa, maximum deformation, 0.22526mm and highest factor of safety i.e 1.76 developed as compared to structure steel for same constant axial tensile load of 150 KN. The deformation in knuckle joint made of aluminum alloy, structure steel under load of 150 KN respectively.

#### TOTAL DEFORMATION OF ALUMINUM ALLOY

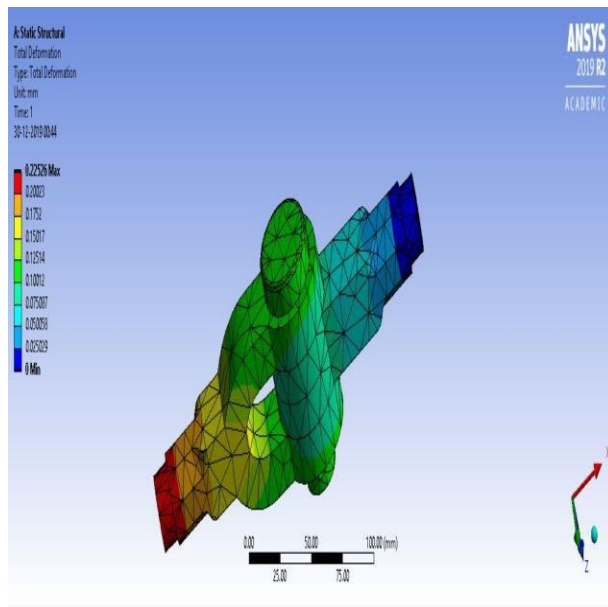

#### EQUIVALENT STRESS OF ALUMINUM ALLOY

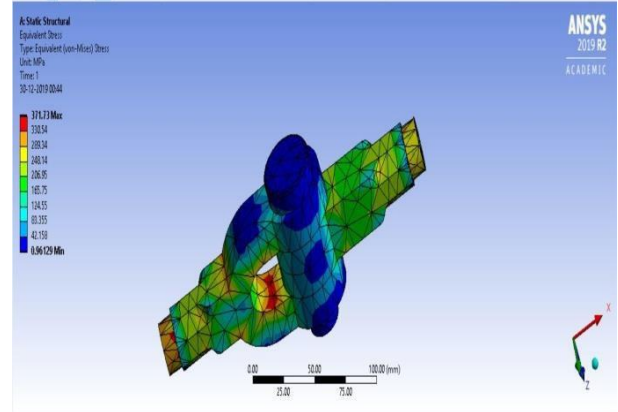

#### TOTAL DEFORMATION OF STRUCTURAL STEEL

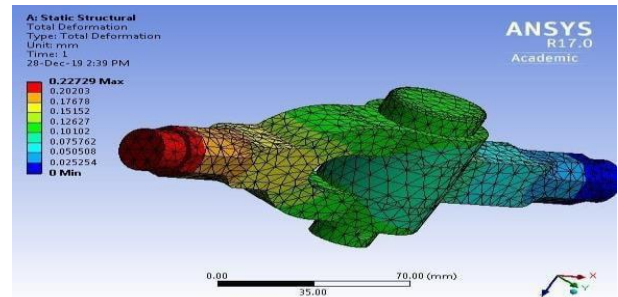

#### EQUIVALENT STRESS OF STRUCTURAL STEEL

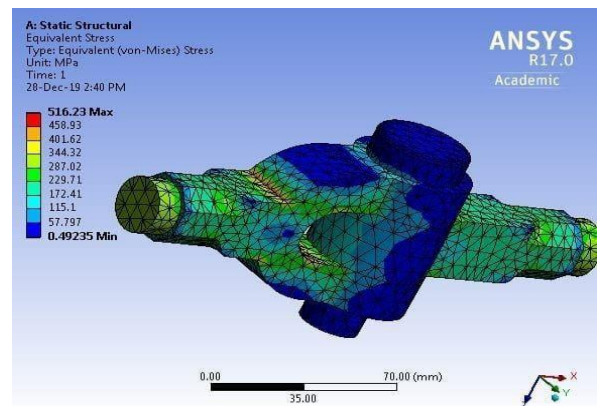

**TABLE 2. Stresses and Deformations for Knuckle joint made of Aluminum alloy, Structural steel.**

Material	Aluminum alloy	Structural steel
Max. Deformation	0.22526	0.22729
Max. Stress	371.73	516.23

#### 4. CONCLUSION

It has been found that knuckle joint made of aluminum have less stress developed i.e. 371.73MPa as compared to structural steel and aluminum have highest factor of safety i.e. 1.76 compared to structure steel. So we can prefer the Aluminum alloy for the development of knuckle joint.

#### REFERENCES

1. Yerrennagoudaru, H, & KB, K. S., Effect of Nozzle Holes and Turbulent Injection on Diesel Engine Performance, International Journal of Recent Development in Engineering and Technology, Volume 2, Issue 6, 2014.
2. H. K. Amarnath, P. Prabhakaran, Sachin A. Bhat & Ruturraj Paatil, A Comparative Analysis Of Thermal Performance And Emission Characteristics Of Methyl Esters Of Karanja And Jatropha Oils Based On A Variable Compression Ratio Diesel Engine, International Journal of Green Energy, Volume 11, Issue 48, 2014
3. Surendra R. Kalbande and Subhash D. Vikhe, Jatropha And Karanj Bio-Fuel: An Alternate Fuel For Diesel Engine, Asian Research Publishing Network (ARPN), Volume 3, 2008.
4. Partha Protim Borthakur, Pranjal Sarmah, Performance Analysis Of Blends Of Jatropha, International Journal of Scientific & Engineering Research, Volume 4, issue 1, 2013.
5. Rohit Sharma<sup>1</sup>, Rana Ranjit Singh<sup>1</sup>, Shailendra Kumar Vishwakarma, Experimental study of the Effect of Fuel Injector nozzle holes on Direct Injection Diesel Engine, IOSR Journal of Mechanical and Civil Engineering (IOSR-JMCE) Volume 7, Issue 4, 2013.
6. Malaysia Chumsunti Santaweek and Adun Janyalertadun, Influence of Nozzle Pressure on Performance and Emission in Compression Ignition Engine Running on Distilled Waste Plastic Oil (DWPO), International Journal of Environmental Science and Development, Volume 4, Issue 3, 2013.
7. Yerrennagoudaru, H, & KB, K. S., Effect of Nozzle Holes and Turbulent Injection on Diesel Engine Performance, International Journal of Recent Development in Engineering and Technology, Volume 2, Issue 6, 2014.
8. H. K. Amarnath, P. Prabhakaran, Sachin A. Bhat & Ruturraj Paatil, A Comparative Analysis Of Thermal Performance And Emission Characteristics Of Methyl Esters Of Karanja And Jatropha Oils Based On A Variable Compression Ratio Diesel Engine, International Journal of Green Energy, Volume 11, Issue 48, 2014.